



## **MMP RLY-100A-24V Reversing Contactor Relay**



### **DESCRIPTION:**

The MMP RLY-100A-24V is an IP-65, reversing polarity contactor. Ideal for controlling permanent magnet motors and gearmotors. Both output terminals rest at ground for dynamic braking in de-energized state. Will handle 100 AMP loads and a 25% duty rating. Splash resistant body, with O-Ring seals. Features Silver plated contacts.

### **SPECIFICATIONS:**

Contact Type: DPDT  
Maximum Current: 100A  
Inrush Current: 200A  
Maximum Switching Voltage: 24V  
Life Cycle: 10,000 Cycles  
Duty Cycle Percentage: 25%  
Maximum On Time: 15 Minutes  
Thermal Operation: 145°C  
Pull in Voltage: 10.3V  
Drop out Voltage: 6.0V  
Coil Resistance: 7.1 - 8.9 Ohms (before use)  
Contact Material Type: Silver Alloy  
Maximum Operation Time: 10ms or less at rated voltage  
Release Time: 10ms or less at rated voltage  
Min. Operating Voltage and Current: 10.3V 5A

**MIDWEST MOTION PRODUCTS**

**DESIGN, MANUFACTURING & DISTRIBUTION - MOTION CONTROL EQUIPMENT**

**www.midwestmotion.com email: sales@midwestmotion.com**



**Dimensional Drawing:**

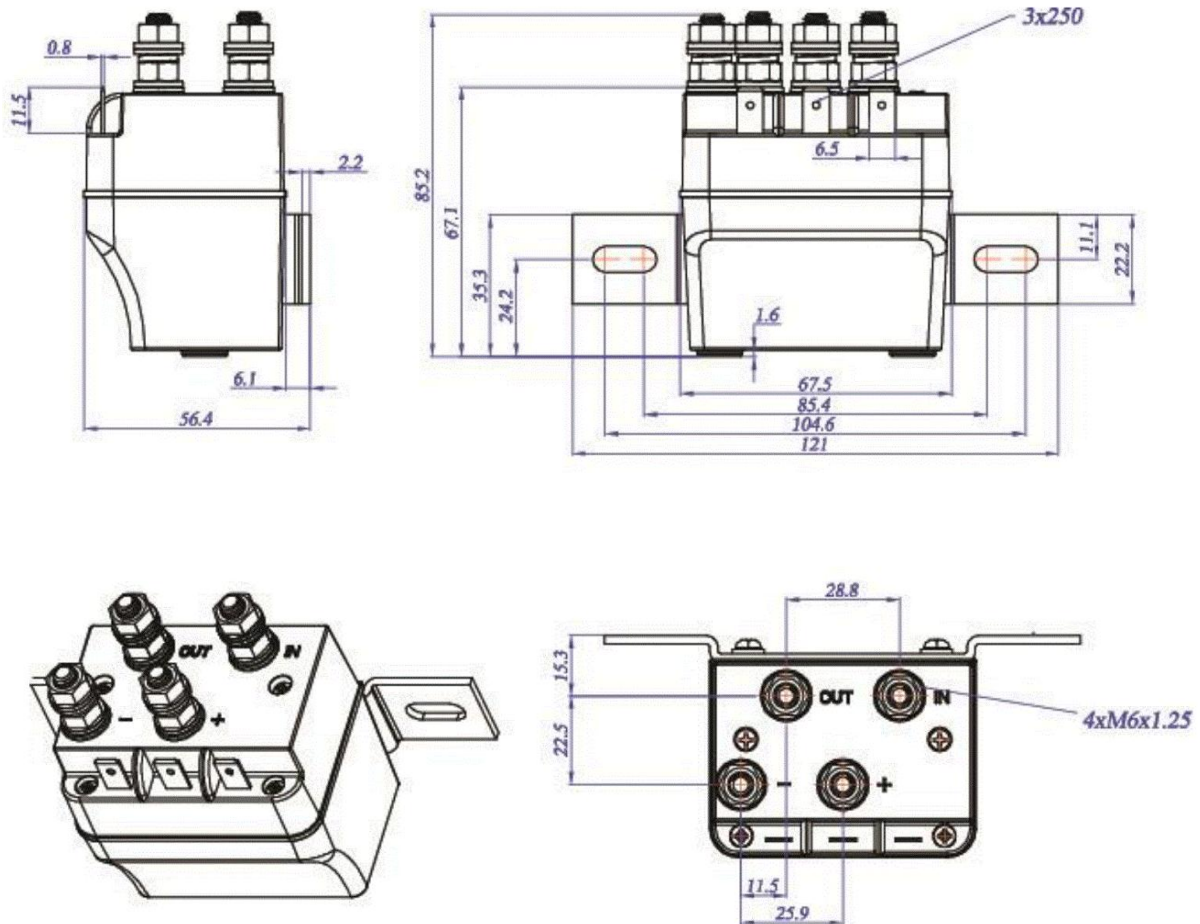

**Schematic:**

100 Amp DC Reversing Relay

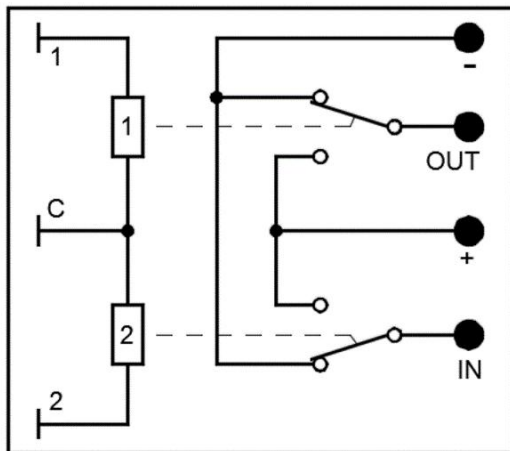

**MIDWEST MOTION PRODUCTS**

DESIGN, MANUFACTURING & DISTRIBUTION - MOTION CONTROL EQUIPMENT

www.midwestmotion.com email: sales@midwestmotion.com

**MIDWEST MOTION PRODUCTS**